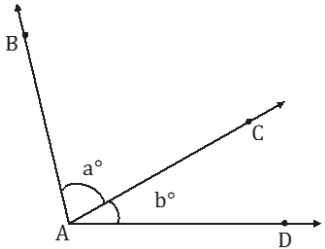
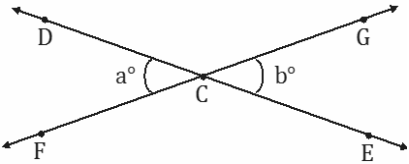
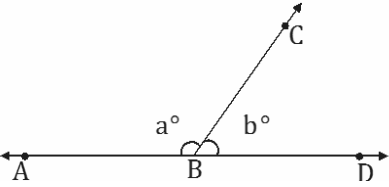
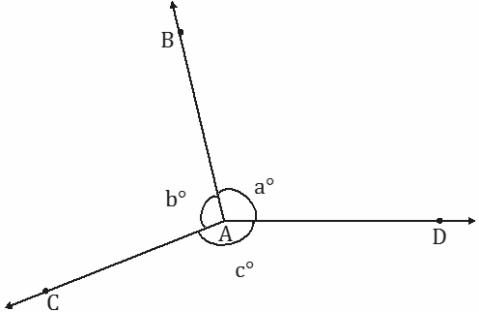

Lesson 10: Angle Problems and Solving Equations

Classwork

Angle Facts and Definitions

Name of Angle Relationship	Angle Fact	Diagram
Adjacent Angles		
Vertical Angles (vert. \angle s)		
Angles on a Line (\angle s on a line)		
Angles at a Point (\angle s at a point)		

Opening Exercise

Use the diagram to complete the chart.

Name the angles that are ...	
Vertical	
Adjacent	
Angles on a line	
Angles at a point	

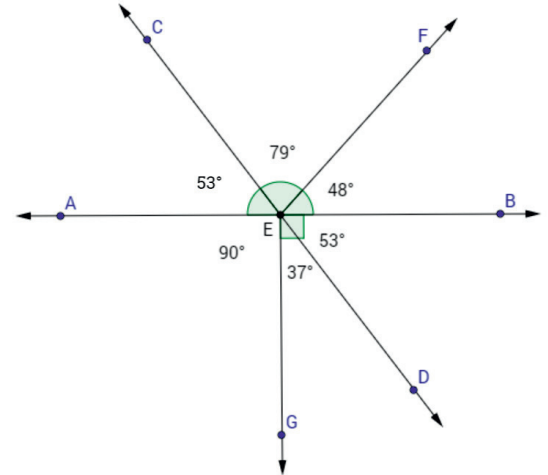

Example 1

Estimate the measurement of x . _____

In a complete sentence, describe the angle relationship in the diagram.

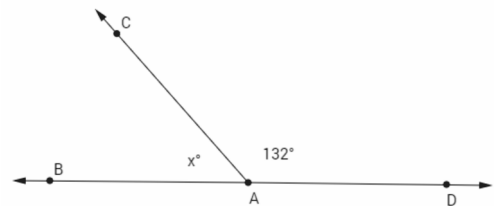

Write an equation for the angle relationship shown in the figure and solve for x . Then, find the measures of $\angle BAC$ and confirm your answers by measuring the angle with a protractor.

Exercise 1

In a complete sentence, describe the angle relationship in the diagram.

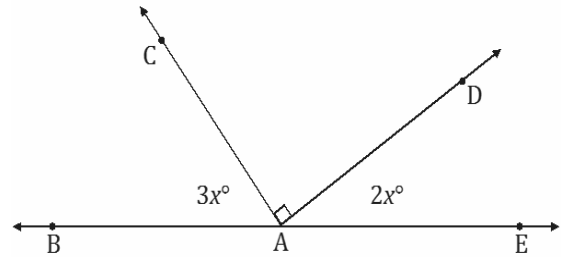

Find the measurements of $\angle BAC$ and $\angle DAE$.

Example 2

In a complete sentence, describe the angle relationship in the diagram.

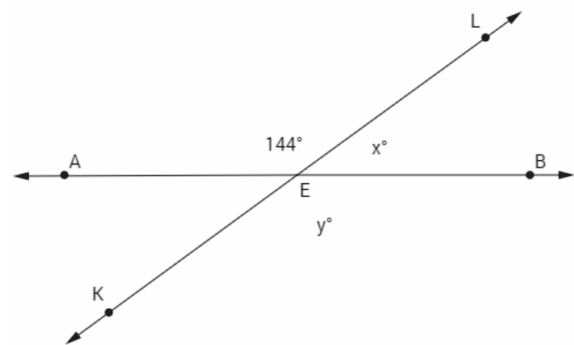

Write an equation for the angle relationship shown in the figure and solve for x and y . Find the measurements of $\angle LEB$ and $\angle KEB$.

Exercise 2

In a complete sentence, describe the angle relationships in the diagram.

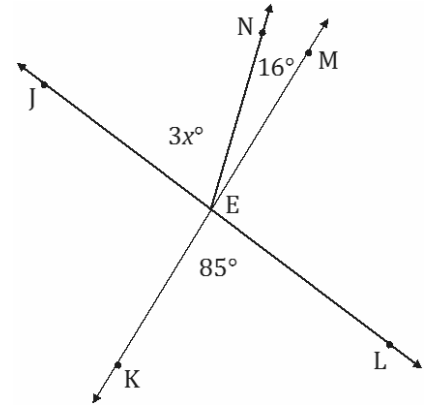

Write an equation for the angle relationship shown in the figure and solve for x .

Example 3

In a complete sentence, describe the angle relationships in the diagram.

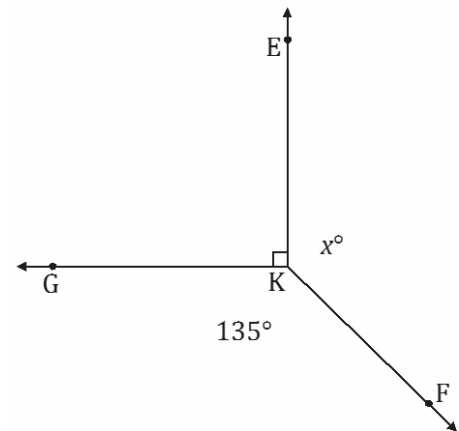

Write an equation for the angle relationship shown in the figure and solve for x . Find the measurement of $\angle EKF$ and confirm your answers by measuring the angle with a protractor.

Exercise 3

In a complete sentence, describe the angle relationships in the diagram.

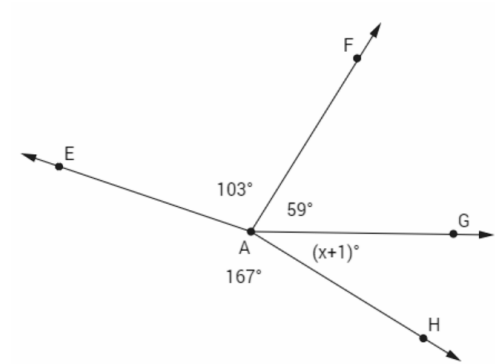

Find the measurement of $\angle GAH$.

Example 4

The following two lines intersect. The ratio of the measurements of the obtuse angle to the acute angle in any adjacent angle pair in this figure is $2 : 1$. In a complete sentence, describe the angle relationships in the diagram.

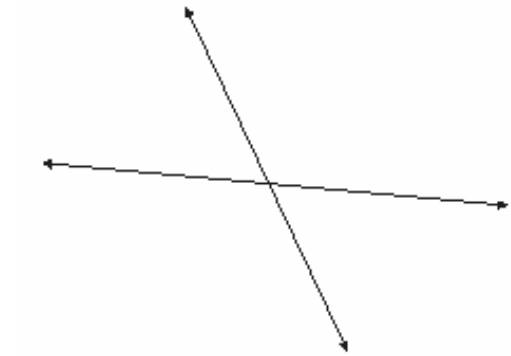

Label the diagram with expressions that describe this relationship. Write an equation that models the angle relationship and solve for x . Find the measurements of the acute and obtuse angles.

Exercise 4

The ratio of $m\angle GFH$ to $m\angle EFH$ is 2 : 3. In a complete sentence, describe the angle relationships in the diagram.

Find the measures of $\angle GFH$ and $\angle EFH$.

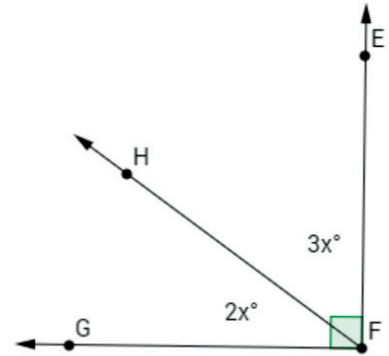
**Relevant Vocabulary**

ADJACENT ANGLES: Two angles $\angle BAC$ and $\angle CAD$ with a common side \overline{AC} are *adjacent angles* if C belongs to the interior of $\angle BAD$.

VERTICAL ANGLES: Two angles are *vertical angles* (or *vertically opposite angles*) if their sides form two pairs of opposite rays.

ANGLES ON A LINE: The sum of the measures of adjacent *angles on a line* is 180° .

ANGLES AT A POINT: The sum of the measures of adjacent *angles at a point* is 360° .

Problem Set

For each question, use angle relationships to write an equation in order to solve for each variable. Determine the indicated angles. You can check your answers by measuring each angle with a protractor.

- In a complete sentence, describe the relevant angle relationships in the following diagram. Find the measurement of $\angle DAE$.

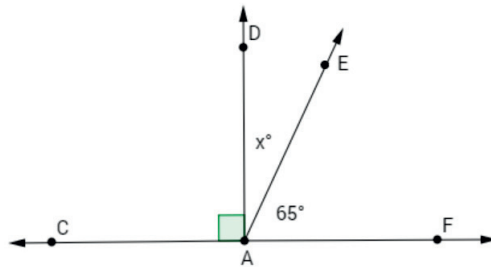

- In a complete sentence, describe the relevant angle relationships in the following diagram. Find the measurement of $\angle QPR$.

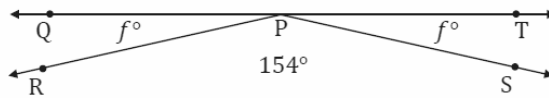

- In a complete sentence, describe the relevant angle relationships in the following diagram. Find the measurements of $\angle CQD$ and $\angle EQF$.

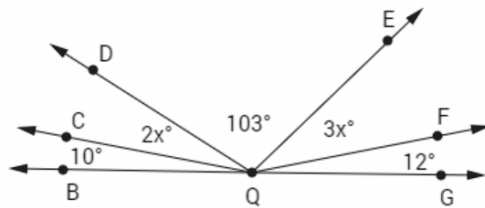

- In a complete sentence, describe the relevant angle relationships in the following diagram. Find the measure of x .

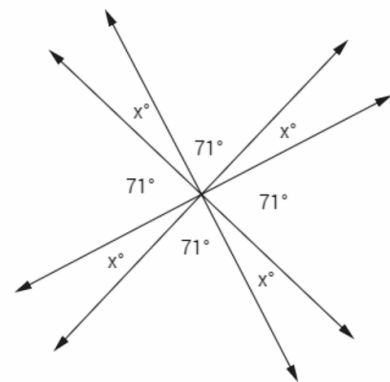

5. In a complete sentence, describe the relevant angle relationships in the following diagram. Find the measures of x and y .

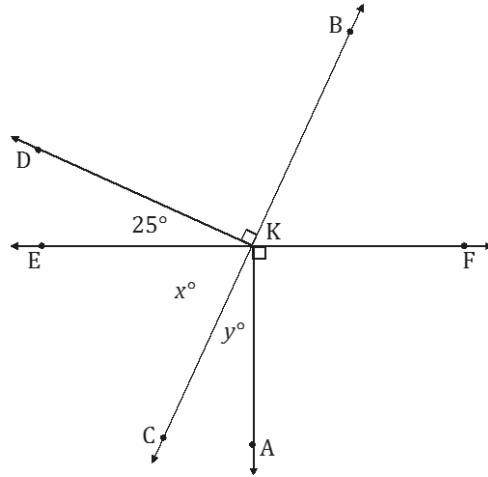

6. In a complete sentence, describe the relevant angle relationships in the following diagram. Find the measures of x and y .

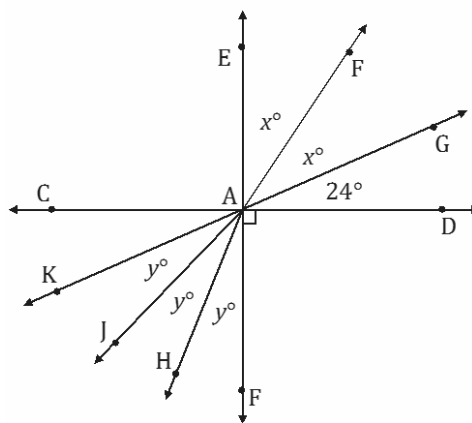

7. In a complete sentence, describe the relevant angle relationships in the following diagram. Find the measures of $\angle CAD$ and $\angle DAE$.

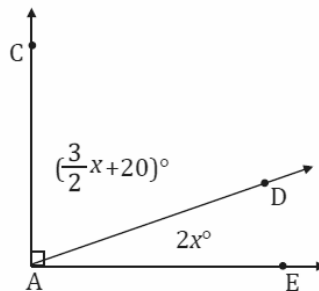

8. In a complete sentence, describe the relevant angle relationships in the following diagram. Find the measure of $\angle CQG$.

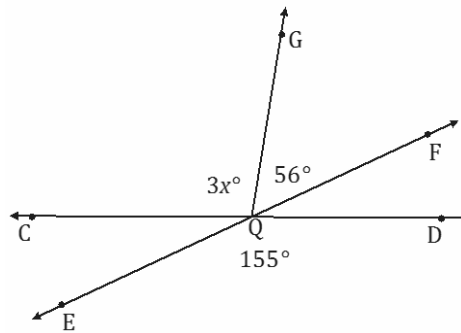

9. The ratio of the measures of a pair of adjacent angles on a line is 4 : 5.
- Find the measures of the two angles.
 - Draw a diagram to scale of these adjacent angles. Indicate the measurements of each angle.
10. The ratio of the measures of three adjacent angles on a line is 3 : 4 : 5.
- Find the measures of the three angles.
 - Draw a diagram to scale of these adjacent angles. Indicate the measurements of each angle.